

(19) World Intellectual Property Organization
International Bureau



(43) International Publication Date
25 March 2004 (25.03.2004)

PCT

(10) International Publication Number
WO 2004/025649 A1

(51) International Patent Classification: G11B 20/18

[KR/KR]; 122-1002 Sibeom Hanshin Apt., 87, Seo-hyun-dong, Bundang-gu, Seongnam-si, 463-050 Gyeonggi-do (KR).

(21) International Application Number:
PCT/KR2003/001878

(74) Agent: LEE, Young-Pil; The Cheonghwa Building, 1571-18, Seocho-dong, Seocho-gu, Seoul 137-874 (KR).

(22) International Filing Date:
9 September 2003 (09.09.2003)

(81) Designated States (national): AE, AG, AL, AM, AT, AU, AZ, BA, BB, BG, BR, BY, BZ, CA, CH, CN, CO, CR, CU, CZ, DE, DK, DM, DZ, EC, EE, EG, ES, FI, GB, GD, GE, GH, GM, HR, HU, ID, IL, IN, IS, JP, KE, KG, KP, KZ, LC, LK, LR, LS, LU, LV, MA, MD, MG, MK, MN, MW, MX, MZ, NI, NO, NZ, OM, PG, PH, PL, PT, RO, RU, SC, SD, SE, SG, SK, SL, SY, TJ, TM, TN, TR, TT, TZ, UA, UG, US, UZ, VC, VN, YU, ZA, ZM, ZW.

(25) Filing Language: English

(26) Publication Language: English

(30) Priority Data:
10-2002-0054755
10 September 2002 (10.09.2002) KR

(71) Applicant (for all designated States except US): SAM-SUNG ELECTRONICS CO., LTD. [KR/KR]; 416, Maetan-dong, Yeongtong-gu, Suwon-si, Gyeonggi-do 442-742 (KR).

(84) Designated States (regional): ARIPO patent (GH, GM, KE, LS, MW, MZ, SD, SL, SZ, TZ, UG, ZM, ZW), Eurasian patent (AM, AZ, BY, KG, KZ, MD, RU, TJ, TM), European patent (AT, BE, BG, CH, CY, CZ, DE, DK, EE, ES, FI, FR, GB, GR, HU, IE, IT, LU, MC, NL, PT, RO, SE, SI, SK, TR), OAPI patent (BF, BJ, CF, CG, CI, CM, GA, GN, GQ, GW, ML, MR, NE, SN, TD, TG).

(72) Inventors; and

(75) Inventors/Applicants (for US only): KO, Jung-Wan [KR/KR]; 315-401 Daewoo Apt., 956-2, Cheongmyung Maeul 3-danji, Youngtong-dong, Paldal-gu, Suwon-si, 442-470 Gyeonggi-do (KR). LEE, Kyung-Geun

Published:
— with international search report

[Continued on next page]

(54) Title: METHOD AND APPARATUS FOR MANAGING DISC DEFECTS

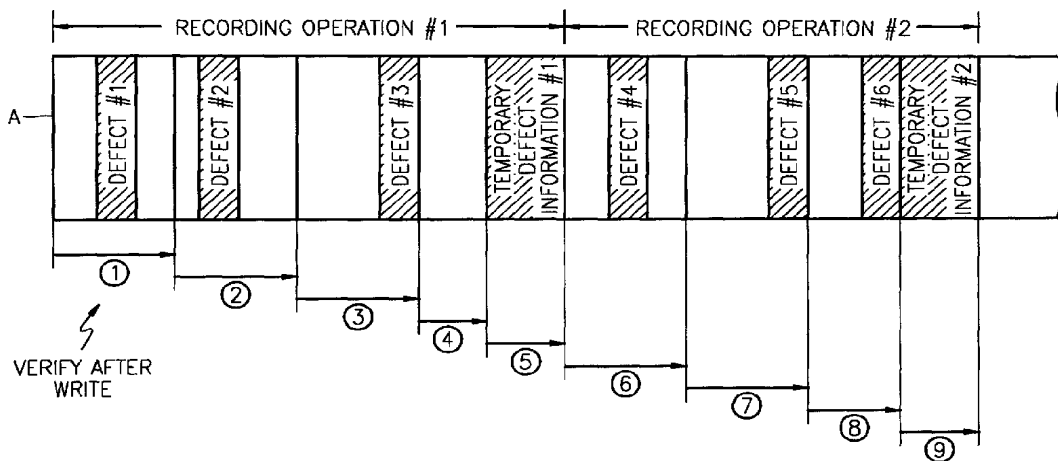

(57) Abstract: Defect management method and apparatus are provided. The method includes (a) recording data in predetermined units of data; (b) verifying the recorded data to detect an area of the disc in which a defect exists; (c) designating from the area having the defect to the following area containing data as a defective area or designating only the area having the defect as a defective area; (d) recording information regarding the designated defective area as temporary defect information in a data area of the disc; and (e) recording information, which is used to manage the temporary defect information, in a temporary defect management information area. The method and apparatus are applicable to write once discs and suitable for recording different types of data, thereby enabling more appropriate real-time data reproduction.

WO 2004/025649 A1



For two-letter codes and other abbreviations, refer to the "Guidance Notes on Codes and Abbreviations" appearing at the beginning of each regular issue of the PCT Gazette.

METHOD AND APPARATUS FOR MANAGING DISC DEFECTS

Technical Field

The present invention relates to disc defect management, and
5 more particularly, to a method and apparatus for managing a defect in a
disc, in a manner regarding different types of data.

Background Art

Defect management is a process of rewriting the data stored in a
10 user data area of a disc in which a defect exists. The data is rewritten
to the disc's data area, thereby compensating the data loss caused by
the defect. In general, defect management is performed using linear
replacement or slipping replacement. In linear replacement, the user
data area in which a defect exists is replaced with a spare data area
15 having no defects. In slipping replacement, the user data area with the
defect is slipped and the next user data area having no defects is used.

Both linear replacement and slipping replacement are applicable
only to discs, such as a DVD-RAM/RW, on which data can be repeatedly
recorded and recording can be performed using a random access
20 method. In other words, linear replacement and slipping replacement
are difficult to apply to write once discs on which recording is allowed
only once. In general, the presence of defects in a disc is detected by
recording data on the disc and confirming whether or not data has been
recorded correctly on the disc. However, once data is recorded on a
25 write once disc, it is impossible to overwrite new data and manage
defects therein.

After the development of CD-R and DVD-R, a high-density write
once disc with a recording capacity of several dozen GBs was introduced.
This type of disc can be used as a backup disc, since it is not expensive
30 and allows random access which enables fast reading operations.
However, defect management is not available for write once discs.

Therefore, a backup operation is discontinued when a defective area, i.e., an area where a defect exists, is detected during the backup operation because defect management on a write once disc is not performed. In general, a backup operation is performed when a system is not
5 frequently used, e.g., at night when a system manager does not operate the system.

Recording of user data recorded from a defective area of the data area to the data area for defect management, is not always preferable. For real-time reproduction of data, it is important to appropriately read
10 data on time. In general, audio/video (AV) data requires reproduction in real time, for it is perceived by the visual and auditory senses of a human being during reproduction. Human visual and auditory senses are more sensitive to an error in real-time reproduction of AV data than an error in reproduction of specific AV data content caused by a trivial defect
15 contained in the AV data. In fact, human ears are incapable of detecting an error when audio data is incompletely reproduced. As specified previously, when an area of a disc is designated as a defective area, slipping replacement can be used to rewrite data to a following area. That is, when an area of a disc is designated as a defective area,
20 the following area where data is recorded is also considered as unavailable and determined to be a defective area, and the data recorded in the defective area is rewritten. In this case, the defective area is skipped and data is read from the next area during reproduction of the data. However, skipping the defective area causes a delay in
25 reading data from the disc, and the delay in reading makes it difficult to reproduce data in real-time. As described above, human ears are more sensitive to an error caused by a failure of real-time reproduction than an error caused by incomplete reproduction of AV data. Unlike AV data, it is very difficult to reproduce, edit, or search for control data when even a
30 small amount of the control data is lost.

Disclosure of the Invention

The present invention provides a defect management method and apparatus that manage a defect occurring in a disc in a manner suitable for recording different types of data, thereby improving reproduction
5 characteristics.

The present invention also provides a defect management method and apparatus that are applicable to a write once disc and manage a defect occurring in that disc in a manner suitable for recording different types of data, thereby improving reproduction characteristics.

10 According to an aspect of the present invention, there is provided a method of managing defects in a disc, comprising: (a) recording data in predetermined units of data; (b) verifying the recorded data to detect an area of the disc in which a defect exists; (c) designating from the area having the defect to the following area containing data as a defective
15 area or designating only the area having the defect as a defective area; (d) recording information regarding the designated defective area as temporary defect information in a data area of the disc; and (e) recording information, which is used to manage the temporary defect information, in a temporary defect management information area.

20 It is preferable that the method further includes (f) repeating (a) through (e) before finalizing of the disc, wherein previously recorded information is recorded with the temporary defect information during (d); and (g) recording information, which is most recently recorded in the temporary defect information area and the temporary defect
25 management information area in a defect management area during the finalizing of the disc.

It is preferable that during (c), from the area having the defect to the following area containing data is designated as a defective area, or only the area having the defect is designated as a defective area,
30 depending on the type of the recorded data. Also, it is more preferable that during (c), only the area having the defect is designated as a

defective area when the recorded data is AV data, and from the area having the defect to the following area containing data is designated as a defective area when the recorded data is control data.

According to another aspect of the present invention, there is provided a method of managing defects in a disc, comprising: (a) recording data in
5 predetermined units of data; (b) verifying the recorded data to detect an area of the disc in which a defect exists; (c) designating from the area having the defect to the following area containing data as a defective area as a defective area, or designating only the area having the defect
10 as a defective area; (d) storing information regarding the designated defective area as first temporary defect information in memory; (e) repeating (a) through (d) before a recording operation is expected to end; (f) reading the temporary defect information from the memory and recording the temporary defect information in a temporary defect
15 information area of the data area so as to correspond to the recording operation, when the recording operation is expected to end; and (g) recording information, which is used to manage the information recorded in the temporary defect information area in (f), in a temporary defect management information area.

20 It is preferable that during (f), information for designating the temporary defect information area is further recorded in the temporary defect information area.

It is preferable that the method further includes (h) repeating (a) through (f) before finalizing of the disc, wherein previously recorded
25 information is recorded with the temporary defect information during (f) in the temporary defect information area; and (i) recording information, which is most recently recorded in the temporary defect information area and the temporary defect management information area, in a defect management area.

30 It is preferable that during (c), from the area having the defect to the following area containing data is designated as a defective area, or

only the area having the defect is designated as a defective area, depending on the type of the recorded data. It is more preferable that during (c), only the area having the defect is designated as a defective area when the recorded data is AV data, and from the area having the defect to the following area containing data is designated as a defective area when the recorded data is control data.

According to yet another aspect of the present invention, there is provided a recording apparatus comprising a recording/reading unit that records data on or reads data from a disc; and a controller that verifies the data recorded on the disc using the recording/reading unit so as to detect an area of the disc in which a defect exists, designates from the area having the defect to the following area containing data as a defective area or designates only the area having the defect as a defective area, creates information regarding the designated defective area, provides the created information to the recording/reading unit, controls the recording/reading unit to record the created information as temporary defect information in a data area of the disc, creates management information for managing the temporary defect information, provides the management information to the recording/reading unit, and controls the recording/reading unit to record the management information in a temporary defect management area.

It is preferable that the controller controls the recording/reading unit to further record the previously recorded information with the information, and controls the recording/reading unit to record information, which is most recently recorded in the temporary defect information area and the temporary defect management information area in a defect management area during finalizing of the disc. It is preferable that the controller designates from the area having the defect to the following area containing data as a defective area, or designates only the area having the defect as a defective area, depending on the type of the recorded data. It is more preferable that the controller designates only

the area having the defect as a defective area when the recorded data is AV data, and designates from the area having the defect to the following area containing data as a defective area when the recorded data is control data.

5 According to still another aspect of the present invention, there is provided a recording apparatus comprising memory; a recording/reading unit that records data on a disc in predetermined units of data and reads the recorded data from the disc; and a controller that verifies the data recorded on the disc using the recording/reading unit so as to defect an
10 area of the disc in which a defect exists; designates from the area having the defect to the following area containing data as a defective area or designates only the area having the defect as a defective area; stores information regarding the designated defective area as first temporary defect information in the memory; repeats the verifying of the data, the
15 designating of the defective area, and the storing of information regarding the designated defective area before a recording operation is expected to end; reads the temporary defect information from the memory when the recording operation is expected to end; provides the read temporary defect information to the recording/reading unit; controls
20 the recording/reading unit to record the temporary defect information in a temporary defect information area of the data area in a manner corresponding to the recording operation; creates management information for managing the temporary defect information area; provides the management information to the recording/reading unit; and
25 controls the recording/reading unit to record the management information in a temporary defect management information area.

It is preferable that the controller creates information for the temporary defect information area, provides the created information to the recording/reading unit, and controls the recording/reading unit to further
30 record the created information in the temporary defect information area.

It is preferable that the controller controls the recording/reading unit to

further record the previously recorded information with the information;
reads information, which is most recently recorded in the temporary
defect information area and the temporary defect management
information area, during the finalizing of the disc; and controls the
5 recording/reading unit to record the most recently recorded information in
the defect management area again. It is preferable that the controller
designates from the area having the defect to the following area
containing data as a defective area or designates only the area having
the defect as a defective area, depending on the type of the recorded
10 data. It is more preferable that the controller designates only the area
having the defect as a defective area when the recorded data is AV data,
and designates from the area having the defect to the following area
containing data as a defective area when the recorded data is control
data.

15

Brief Description of the Drawings

The above and/or other aspects and/or advantages of the present
invention will become more apparent and more readily appreciated by
describing in detail embodiments thereof with reference to the
20 accompanying drawings in which:

FIG. 1 is a block diagram of a recording apparatus according to a
preferred embodiment of the present invention;

FIG. 2A illustrates a structure of a single record layer disc
according to a preferred embodiment of the present invention;

25 FIG. 2B illustrates a structure of a double record layer disc
according to a preferred embodiment of the present invention;

FIG. 3 illustrates details of the structures of the discs shown in
FIGs. 2A and 2B;

30 FIG. 4 is a diagram illustrating a process in which temporary
defect information is created and recorded, according to a preferred
embodiment of the present invention;

FIG. 5 illustrates data structures of temporary defect information according to a preferred embodiment of the present invention;

FIG. 6 illustrates data structures of information regarding defect #i and information regarding temporary defect information #i, which are recorded in a temporary defect information area;

FIG. 7 is a flowchart illustrating a defect management method according to a preferred embodiment of the present invention; and

FIG. 8 is a flowchart illustrating a defect management method according to another preferred embodiment of the present invention.

10

Best mode for carrying out the Invention

FIG. 1 is a block diagram of a recording apparatus according to a preferred embodiment of the present invention. Referring to FIG. 1, the recording apparatus includes a recording/reading unit 1, a controller 2, and a memory 3. The recording/reading unit 1 records data on a disc 100, which is an information storage medium according to a preferred embodiment of the present invention, and reads back the data from the disc 100 to verify the accuracy of the recorded data. The controller 2 performs defect management according to the present invention. In this embodiment, the controller 2 uses a verify-after-write method in which the accuracy of data is verified after recording the data in predetermined units. More specifically, the controller 2 makes the recording/reading unit 1 to record user data on the disc 100 in predetermined units, and verifies the accuracy of the user data for detection of defects in the user data. Next, if a defect is detected, the controller 2 creates defect information that indicates the position of a defective area on the disc 100.

If an area containing a defect is detected, the controller 2 designates only the specific area as a defective area, or designates from the specific area to the following area containing data. Every time defect information is created, the controller 2 stores it in the memory 3. When the amount of stored defect information reaches a predetermined level, it

is recorded as temporary defect information on the disc 100. Also, the controller 2 records management information, which is used to manage the recorded temporary defect information, as temporary defect management information on the disc 100.

5 In this embodiment, recording temporary defect information and temporary defect management information on the disc 100 is periodically performed per recording operation. A recording operation is a unit of work determined according to a user's intention or is a recording work to be performed. According to this embodiment, a recording operation
10 indicates a process in which the disc 100 is loaded into the recording apparatus, data is recorded on the disc 100, and the disc 100 is taken out from the recording apparatus. During the recording operation, data is recorded and verified at least once; in general, data is verified several times. When a user presses the eject button (not shown) of the
15 recording apparatus in order to remove the disc 100 after recording of data, the controller 2 expects the recording operation to be terminated. Next, the controller 2 creates temporary defect information and temporary defect management information, and provides them to the recording/reading unit 1 to be recorded on the disc 100. The temporary
20 defect information, which is obtained as a result of the recording and verifying by the controller 2, is stored in the memory 3.

If the recording of data on the disc 100 is completed, i.e., no more data will be recorded on the disc 100 (the disc 100 is to be finalized), the controller 2 records the temporary defect information and the temporary
25 defect management information in a defect management area (DMA) of the disc 100.

FIGs. 2A and 2B illustrate structures of a disc according to a preferred embodiment of the present invention. FIG. 2A illustrates in detail a single record layer disc representation of disc 100 having a
30 record layer *LO*. The disc 100 includes a lead-in area, a data area, and a lead-out area. The lead-in area is located in an inner part of the disc

100 and the lead-out area is located in an outer part of the disc 100. The data area is present between the lead-in area and the lead-out area, and divided into a user data area and a spare area. The user data area is an area where user data is recorded, and the spare area is the
5 substitute area for a user data area having a defect, serving to compensate for loss in the recording area due to a defect. On the assumption that defects may occur within the disc 100, it is preferable that the spare area assumes 5% of the entire data capacity of the disc 100, so that a greater amount of data can be recorded on the disc 100.
10 Also, it is preferable that the spare area is provided at the end of the recording area of the disc 100. Especially, in the case of a write once disc, the spare area must be located at the end of the recording area of the disc. This allows slipping replacement to be performed while the spare area data is recorded, starting from the inner part toward the outer
15 part of the disc 100.

In this embodiment, the spare area is present only between the user data area and the lead-out area. If necessary, a portion of the user data area may be used as another spare area, that is, more than one spare area may be present between the user data area and the
20 lead-out area.

FIG. 2B illustrates a double record layer disc representation of disc 100 having two record layers *L0* and *L1*. A lead-in area, a data area, and an outer area are sequentially formed from the inner part of the first record layer *L0* to its outer part. Also, an outer area, a data
25 area, and a lead-out area are sequentially formed from the outer part of the second record layer *L1* to its inner part. Unlike the single record layer disc of FIG. 2A, the lead-out area is present in the inner part of the disc 100 of FIG. 2B. That is, the disc 100 of FIG. 2B has an opposite track path (OTP) in which data is recorded starting from the lead-in area
30 of the first record layer *L0* toward the outer area and continuing from the outer area of the second record layer *L1* to the lead-out area.

FIG. 3 illustrates details of the structures of the disc 100 shown in FIGs. 2A and 2B, according to embodiments of the present invention. Referring to FIG. 3, a DMA is present at least once in the lead-in area, the lead-out area, or the outer area of the disc 100. Also, a temporary defect management area is formed at least once in the lead-in area or the lead-out area. A temporary defect information area is formed in the data area according to a recording operation.

In general, information which relates to managing defects in the disc 100 is recorded in the DMA. Such information includes the structure of the disc 100 for defect management, the position of defect information, whether defect management is performed or not, and the position and size of a spare area. In the case of a write once disc, new data is recorded after previously recorded data when the previously recorded data changes. In general, when a disc is loaded into a recording/reproducing apparatus, the apparatus reads data from a lead-in area and a lead-out area of the disc to determine how to manage the disc, and record data on or read data from the disc. However, if the amount of data recorded in the lead-in area increases, a longer time is spent on preparing the recording or reproducing of data after loading the disc. Accordingly, the present invention proposes temporary defect management information and temporary defect information. That is, only the temporary defect management information, which is comparatively more important than the temporary defect information, is recorded in the lead-in area. The temporary defect information is recorded in the data area. It is preferable that new information is added to the previously recorded information in the temporary defect information area so that all recorded information is accumulated therein. The recording/reproducing apparatus reads the most recently recorded temporary defect information and detects defects throughout the disc based on the reading result. Thus, information regarding the location of the most recently recorded temporary defect information is recorded in

the temporary defect management information area where the temporary defect management information is recorded.

More specifically, information regarding a defect that occurred in a recording unit #1 and information regarding a defect that occurred in a recording unit #2 are recorded in a temporary defect information area #1 and a temporary defect information area #2, respectively. Defect management information for managing the temporary defect information areas #1, #2, ..., and #n is recorded in the temporary defect management information area. If additional data cannot be recorded on the disc 100 or a user does not wish to record any more data on the disc 100, i.e., the disc 100 needs to be finalized, the temporary defect information recorded in the temporary defect information area and the temporary defect management information recorded in the temporary defect management information area are all recorded in the DMA.

The reason for recording the temporary defect management information and the temporary defect information in the DMA again will now be explained. In the case that additional data will not be recorded on the disc 100, i.e., the disc 100 needs to be finalized, the temporary defect management information, which is updated several times, and the temporary defect information, which is recorded in the data area, are rewritten to the DMA of the lead-in area, thereby enabling the fast reading of information recorded on the disc 100. Also, it is possible to increase the reliability of information by recording the defect management information in a plurality of areas.

In this embodiment, defect information recorded in the temporary defect information areas #0 through #i-1 is recorded repeatedly in a temporary defect information area #i. Therefore, it is sufficient to read the defect information from the last temporary defect information area and record this information in the DMA again during the finalizing of the disc 100.

FIG. 4 is a diagram illustrating a process in which temporary

defect information is created and recorded.

Here, a unit of data may be processed in units of sectors or clusters. A sector denotes a minimum unit of data that is managed in a file system of a computer or in an application, and a cluster denotes a
5 minimum unit of data that can be physically recorded on a disc at once. In general, one or more sectors constitute a cluster.

There are two types of sectors: a physical sector and a logical sector. The physical sector is an area on a disc where a sector of data is to be recorded. An address for detecting the physical sector is called
10 a physical sector number (PSN). The logical sector is a unit for managing data in a file system or in an application. An address for detecting the logical sector is called a logical sector number (LSN). A disc recording/reproducing apparatus detects the recording position of data using a PSN and, when recording data on a disc, the entire data is
15 managed in units of LSNs in a computer or in an application. The relationship between an LSN and a PSN is changed by a controller of the recording/reproducing apparatus, based on whether or not the disc contains a defect and an initial position of recording data.

Referring to FIG. 4, A denotes a data area in which PSNs are
20 allocated to a plurality of sectors (not shown) in ascending order. In general, each LSN corresponds to at least one PSN. However, since LSNs are allocated to non-defective sectors in ascending order, the correspondence between the PSNs and the LSNs is not maintained when a disc has a defective area, even if the size of a physical sector is
25 the same as that of a logical sector.

① through ⑨ denotes units of data in which verifying work is performed after recording work. In detail, a recording apparatus records user data in section ①, returns to the start of section ①, and checks if the user data is appropriately recorded or a defect exists in section ①.
30 If a defect is detected, only the area covering the defect in section ① is designated as a defective area. Here, the defect is designated as

defect #1. Next, the recording apparatus records the user data in section ②, returns to the start of section ②, and checks if the user data is appropriately recorded or a defect exists in the start. If a defect is detected, only the area covering the defect in section ② is designated as a defective area and the defect is designated as defect #2. Likewise, defect #3 is determined with respect to section ③. However, in the case of section ③, from the area containing the defect to the following area containing data is designated as the defective area. Since a defect is not detected in section ④, a defective area is not determined in section ④.

Temporary defect information #1 is recorded when recording operation #1 is expected to end, and after the recording and verifying of data in the section ④, i.e., when a user presses the eject button of a recording apparatus or recording of user data allocated in a recording operation is completed. Temporary defect information #1 contains information regarding defects #1 through #3 occurring in sections ① through ④. Only an area containing a defect is determined to be a defective area in section ④, and from the area containing a defect to the following area containing data is determined to be the defective area in sections ⑤ and ⑥. Similarly, temporary defect information #2 is recorded according to recording operation #2. Temporary defect information #1 also contains information regarding an area part in which user data is recorded according to recording operation #1, the part having a defect and thus being designated as a defective area. Also, temporary defect information #2 contains information regarding an area part in which the user data is recorded according to recording operation #2, the part having a defect and thus being designated as another defective area. Also, temporary defect information #2 further contains the information contained in temporary defect information #1.

When a defect is detected from an area of disc 100, data

recording may be performed in one of two ways: (i) only the specified area is designated as a defective area, data recorded in the defective area is not rewritten, and data recording is continued after the defective area; and (ii) from the area containing the defect to the following area containing data is designated a defective area, data recorded in the defective area is rewritten, that is, the defective data is restored using slipping replacement, and then, the data recording is continued.

Selection of the above ways (i) and (ii) is determined depending on the type of data to be recorded. For instance, if the data to be recorded is AV data that needs to be reproduced in real time, (i) is selected, that is, only the area containing the defect is designated as a defective area and data recorded in the defective area is not rewritten. In contrast, if the data to be recorded is control data, such as navigation data that is used to reproduce, search for, or edit the AV data, (ii) is selected. In data reproduction, the degree of error due to control data loss is greater than that due to AV data loss.

The reason for choosing to rewrite data recorded in a defective area, based on data characteristics will now be described. In general, AV data needs to be reproduced in real time because it is perceived by human ears when it is reproduced. Human visual and auditory senses are more sensitive to an error in real-time reproduction of AV data than an error in reproduction of specific AV data content caused by a trivial defect contained in the AV data. In fact, human ears are incapable of detecting an error when audio data is incompletely reproduced. As specified previously, when an area of a disc is designated as a defective area, slipping replacement can be used to rewrite data to a following area. That is, when an area of a disc is designated as a defective area, the following area where data is recorded is also considered as unavailable and determined to be a defective area, and the data recorded in the defective area is rewritten. In this case, the defective area is skipped and data is read from the next area during reproduction

of the data. However, skipping the defective area causes a delay in reading data from the disc, and the delay in reading makes it difficult to reproduce data in real-time. As described above, human ears are more sensitive to an error caused by a failure of real-time reproduction than an error caused by incomplete reproduction of AV data. In general, a disc drive included in a reproducing apparatus has various types of error correction functions such as error correction code (ECC), and is thus capable of restoring at least a portion of data that cannot be appropriately read during the reproduction operation. For this reason, when a defect exists in an area of a disc during AV data recording, only the specified area is designated as the defective area and data recorded in the defective area is not rewritten in another area.

A case exists where AV data is reproduced in real time but it need not to be recorded in real time. The case includes storing AV data in an auxiliary storage device, such as a hard disc drive (HDD), and recording the stored AV data on the disc 100. That is, AV data can be recorded using an editing tool for AV data. In particular, AV data that does not need to be recorded in real time can be easily recorded according to the present invention.

In contrast, if only a portion of control data is lost, it is difficult to reproduce, edit, and search for the control data. Thus, if a defect exists in an area of a disc during the recording of control data, both the area having the defect and the following area containing data is designated as a defective area and data recorded in the defective area is rewritten in another area.

The diagram of FIG. 4 illustrates data recording, more specifically, a first recording operation on a disc where a defect exists, using one of two ways: (i) only the area having the defect is designated as a defective area and data recording is continued after the defective area without rewriting data previously recorded in the defective area, and (ii) a defective area is designated to include the area having the defect and

the following area containing data and the data previously recorded in the defective area is rewritten. However, the present invention is not limited to this description, that is, disc defects may be processed another way rather than the way (i) or the way (ii), depending on a format of recorded data.

FIG. 5 illustrates data structures of temporary defect information according to preferred embodiment of the present invention. Referring to FIG. 5, temporary defect information #1 contains information regarding defect #1, defect #2, and defect #3. The information regarding defect #1 discloses the position of defect #1 recorded in the disc, the information regarding defect #2 discloses the position of defect #2, and the information regarding defect #3 discloses the position of defect #3.

Temporary defect information #1 also includes the information regarding defect #1, the information regarding defect #1, the information regarding defect #3, and the information regarding temporary defect information #1. The information regarding temporary defect information #1 indicates the position of temporary defect information #1. It is not required to read the information recorded in temporary defect information #1 during reproduction of user data, since the user data is not recorded in temporary defect information #1. That is, for the reproduction of the user data, it is meaningless to distinguish between defective area #i and temporary defect information #1. Therefore, temporary defect information #1 contains the information regarding its position and thus can be used as useful information, for example, it can be used to indicate that the user data is not recorded in temporary defect information #1 during the reproduction of the user data.

Temporary defect information #2 further contains information regarding defects #4, #5, and #6, in addition to the information recorded in temporary defect information #1. Temporary defect information #2 also contains information regarding the position of temporary defect information #1.

FIG. 6 illustrates data structures of information regarding defect #i recorded in a temporary defect information area, and information regarding temporary defect information #i. Referring to FIG. 6, the information regarding defect #i includes first state information, second state information, starting and ending points, and a reserved area of defect #i. State information is flag information that indicates whether the present area is a defective area in which a defect exists or is a temporary defect information area in which temporary defect information is recorded. In this embodiment, the first state information is included in the information regarding defect #i and thus must be understood as flag information indicating that the present area is a defective area. The second state information is flag information that indicates one of two options. The first option declares that only the area having the defect is designated as the defective area and that data recording is continued after the defective area without any rewriting of the data previously recorded in the defective area. The second option declares that from the area having the defect to the following area containing data is designated as a defective area and the data recorded in the defective area is rewritten. In the case of defect area #1 shown in FIG. 4, which includes only the area having the defect, the second state information discloses designation of a defective area covering defect area #1 and data recorded in defect area #1 as not rewritten. The information regarding the starting point represents the start of the present area, i.e., the start of the defect #i. The information regarding the ending point represents the end of the present area, i.e., the end of the defect #i. The reserved area is referred to as an area that is reserved for recording other information.

The information regarding temporary defect information #i also includes first state information, second state information, starting and ending points, and a reserved area of temporary defect information #i. State information is flag information that indicates whether the present

area is a defective area in which a defect exists or is an area in which temporary defect information is recorded. The first state information included in the information regarding temporary defect information #i is flag information indicating that a present area is an area in which
5 temporary defect information is recorded, rather than an area in which a defect exists. The inclusion of the second state information into the information regarding temporary defect information #i is optional. The second state information is flag information indicating the same as described for the information regarding defect #i. If the verify-after-write
10 method is also performed on data recorded in a temporary defect information area and the data is rewritten when a defect exists in the temporary defect information area, the second state information is flag information indicating the rewriting of the data.

Hereinafter, a defect management method according to the
15 present invention will be described.

FIG. 7 is a flowchart illustrating a defect management method according to a preferred embodiment of the present invention. Referring to FIG. 7, in action 701, a recording apparatus records defect information, regarding data recorded according to a first recording
20 operation, as first temporary defect information in a data area of a disc. This process serves to manage the defect in the disc. In action 702, the recording apparatus records defect management information, which is used to manage the first temporary defect information, as first temporary defect management information in a temporary defect management
25 information area in at least one of a lead-in area and a lead-out area of the disc. In action 703, the recording apparatus records the first temporary defect information and defect information, regarding data recorded according to a second recording operation, as second temporary defect information in the data area. In action 704, the
30 recording apparatus records defect management information, which is used to manage the second temporary defect information, as second

temporary defect management information in the temporary defect management information area. In action 705, it is checked whether the disc needs to be finalized or not. In action 706, if it is determined in step 705 that the disc does not need to be finalized, actions 701 through 704 are repeated while indexes, which are given to the recording operations, the temporary defect information, and the temporary defect management information, are increased by 1. During the finalizing of the disc, the most recent defect management information and temporary defect information, which are recorded until step 704, are recorded in a DMA in action 707. That is, the most recently recorded temporary defect management information and temporary defect information are recorded as the final temporary defect management information and temporary defect information in the DMA. In action 707, the final temporary defect information and defect management information may be recorded repeatedly in the DMA to increase the reliability of data detection. Further, the verify-after-write method may be performed on the final temporary defect management information and temporary defect information. If a defect is detected from this information, the area of the disc in which the defect exists and data recorded after the area with the defect may be regarded as unavailable, i.e., they are designated as a defective area, and the final temporary defect management information and temporary defect information may be recorded again after the defective area.

FIG. 8 is a flowchart illustrating a defect management method according to another embodiment of the present invention. Referring to FIG. 8, a recording apparatus records user data on a data area of a disc in predetermined units of data to facilitate the verify-after-write method, in action 801. In action 802, the data recorded in action 801 is verified to detect the existence of defects in any area of the data area where a defect exists. In action 803, it is determined whether data recorded in the area having the defect will be rewritten or not. As mentioned above,

the rewriting of data is determined in consideration of the characteristics of data to be recorded. In one option, only the area with a defect is designated as the defective area and data recorded in the defective area is not rewritten. In the other option, both the area with the defect and
5 the following area containing data are designated as the defective area and data recorded in the defective area is rewritten.

If it is determined in action 803 that the data recorded in the area having the defect will not be rewritten, defect information is created in action 804 and used to designate only the area having the defect as the
10 defective area. In contrast, if it is determined in action 803 that the data recorded in the area having the defect will be rewritten, defect information is created in action 805, and used to designate the area from the area having the defect to the following area containing data as the defective area. In action 806, the defect information created in action
15 804 or action 805 is stored as first temporary defect information. In action 807, it is checked whether a recording operation is expected to end. If it is determined in step 807 that the recording operation is not likely to end, actions 801 through 806 are repeated before the end of the recording operation.

20 If it is determined in action 807 that the recording operation is likely to end, i.e., the recording of the user data is complete by user input or according to the recording operation, the first temporary defect information is read and recorded in temporary defect information area #1 of the data area, in action 808. In action 809, information designating
25 temporary defect information area #1 as a defective area is further recorded in first temporary defect information area #1. In action 810, first temporary defect management information #1, which is used to manage temporary defect information #1, is recorded in a temporary defect management information area. In action 811, it is checked
30 whether the disc needs to be finalized. If it is determined in action 811 that the disc is not to be finalized, actions 801 through 810 are repeated

before the finalizing. In action 812, indexes, which are given to the temporary defect information, the temporary defect information area, and the temporary defect management information, are increased by 1 whenever actions 801 through 810 are repeated. If it is determined in action 811 that the disc needs to be finalized, the most recently recorded temporary defect information #i and temporary defect management information #i are recorded as the final temporary defect information and temporary defect management information in a DMA in action 813. The final defect information and defect management information may be recorded repeatedly in the DMA several times, thereby increasing the reliability of data detection. Further, the verify-after-write method may be performed on the final temporary defect management information and temporary defect information. If a defect is detected from this information, the area of the disc in which the defect exists and the following area containing data may be regarded as unavailable, i.e., the two areas are designated as a defective area, and the final temporary defect management information and temporary defect information may be again recorded after the defective area.

20 Industrial Applicability

As described above, the present invention provides a disc defect management method that is applicable to write once discs and suitable for recording different types of data, thus enabling more appropriate real-time data reproduction. Further, according to the present invention, a temporary defect information area is allotted to the data area of a disc, which stores defect information without reducing the recording capacity of the disc. During the finalization of a disc, only the most recently recorded defect information is read from the temporary defect information area and recorded in a defect management area (DMA), thereby enabling efficient use of the DMA whose recording capacity is limited. Meanwhile, it is possible to record user data on even a write

once disc while performing defect management, thereby more stable backup operations can be performed without interruptions.

Although a few embodiments of the present invention have been shown and described, it would be appreciated by those skilled in the art
5 that changes may be made in this embodiment without departing from the principles and spirit of the invention, the scope of which is defined in the claims and their equivalents.

What is claimed is:

1. A method of managing defects in a disc, comprising:
 - (a) recording data in predetermined units of data;
 - (b) verifying the recorded data to detect an area of the disc in
5 which a defect exists;
 - (c) designating from the area having the defect to the following area containing data as a defective area or designating only the area having the defect as a defective area;
 - (d) recording information regarding the designated defective
10 area as temporary defect information in a data area of the disc; and
 - (e) recording information, which is used to manage the temporary defect information, in a temporary defect management information area.

- 15 2. The method of claim 1, further comprising;
 - (f) repeating (a) through (e) before finalizing of the disc, wherein previously recorded information is recorded with the temporary defect information during (d); and
 - (g) recording information, which is most recently recorded in
20 the temporary defect information area and the temporary defect management information area in a defect management area during the finalizing of the disc.

- 25 3. The method of claim 1, wherein during (c), from the area having the defect to the following area containing data is designated as a defective area, or only the area having the defect is designated as a defective area, depending on the type of the recorded data.

- 30 4. The method of claim 3, wherein during (c), only the area having the defect is designated as a defective area when the recorded data is AV data, and from the area having the defect to the following

area containing data is designated as a defective area when the recorded data is control data.

- 5 5. A method of managing defects in a disc, comprising:
- (a) recording data in predetermined units of data;
- (b) verifying the recorded data to detect an area of the disc in
which a defect exists;
- (c) designating from the area having the defect to the following
area containing data as a defective area as a defective area, or
10 designating only the area having the defect as a defective area;
- (d) storing information regarding the designated defective area
as first temporary defect information in memory;
- (e) repeating (a) through (d) before a recording operation is
expected to end;
- 15 (f) reading the temporary defect information from the memory
and recording the temporary defect information in a temporary defect
information area of the data area so as to correspond to the recording
operation, when the recording operation is expected to end; and
- (g) recording information, which is used to manage the
20 information recorded in the temporary defect information area in (f), in a
temporary defect management information area.

6. The method of claim 5, wherein during (f), information for
designating the temporary defect information area is further recorded in
25 the temporary defect information area.

7. The method of claim 6, further comprising:
- (h) repeating (a) through (f) before finalizing of the disc,
wherein previously recorded information is recorded with the temporary
30 defect information during (f) in the temporary defect information area;
and

(i) recording information, which is most recently recorded in the temporary defect information area and the temporary defect management information area, in a defect management area.

5 8. The method of claim 5, wherein during (c), from the area having the defect to the following area containing data is designated as a defective area, or only the area having the defect is designated as a defective area, depending on the type of the recorded data.

10 9. The method of claim 8, wherein during (c), only the area having the defect is designated as a defective area when the recorded data is AV data, and from the area having the defect to the following area containing data is designated as a defective area when the recorded data is control data.

15 10. A recording apparatus comprising;
a recording/reading unit that records data on or reads data from a disc; and
a controller that verifies the data recorded on the disc using the
20 recording/reading unit so as to detect an area of the disc in which a defect exists, designates from the area having the defect to the following area containing data as a defective area or designates only the area having the defect as a defective area, creates information regarding the designated defective area, provides the created information to the
25 recording/reading unit, controls the recording/reading unit to record the created information as temporary defect information in a data area of the disc, creates management information for managing the temporary defect information, provides the management information to the recording/reading unit, and controls the recording/reading unit to record
30 the management information in a temporary defect management area.

11. The recording apparatus of claim 10, wherein the controller controls the recording/reading unit to further record the previously recorded information with the information, and controls the recording/reading unit to record information, which is most recently recorded in the temporary defect information area and the temporary defect management information area in a defect management area during finalizing of the disc.

12. The recording apparatus of claim 10, wherein the controller designates from the area having the defect to the following area containing data as a defective area, or designates only the area having the defect as a defective area, depending on the type of the recorded data.

13. The recording apparatus of claim 12, wherein the controller designates only the area having the defect as a defective area when the recorded data is AV data, and designates from the area having the defect to the following area containing data as a defective area when the recorded data is control data.

14. A recording apparatus comprising:
memory;
a recording/reading unit that records data on a disc in predetermined units of data and reads the recorded data from the disc;
and

a controller that verifies the data recorded on the disc using the recording/reading unit so as to defect an area of the disc in which a defect exists; designates from the area having the defect to the following area containing data as a defective area or designates only the area having the defect as a defective area; stores information regarding the designated defective area as first temporary defect information in the

memory; repeats the verifying of the data, the designating of the defective area, and the storing of information regarding the designated defective area before a recording operation is expected to end; reads the temporary defect information from the memory when the recording
5 operation is expected to end; provides the read temporary defect information to the recording/reading unit; controls the recording/reading unit to record the temporary defect information in a temporary defect information area of the data area in a manner corresponding to the recording operation; creates management information for managing the
10 temporary defect information area; provides the management information to the recording/reading unit; and controls the recording/reading unit to record the management information in a temporary defect management information area.

15 15. The recording apparatus of claim 14, wherein the controller creates information for the temporary defect information area, provides the created information to the recording/reading unit, and controls the recording/reading unit to further record the created information in the temporary defect information area.

20 16. The recording apparatus of claim 14, wherein the controller controls the recording/reading unit to further record the previously recorded information with the information; reads information, which is most recently recorded in the temporary defect information area and the
25 temporary defect management information area, during the finalizing of the disc; and controls the recording/reading unit to record the most recently recorded information in the defect management area again.

30 17. The recording apparatus of claim 14, wherein the controller designates from the area having the defect to the following area containing data as a defective area or designates only the area having

the defect as a defective area, depending on the type of the recorded data.

- 5 18. The recording apparatus of claim 17, wherein the controller designates only the area having the defect as a defective area when the recorded data is AV data, and designates from the area having the defect to the following area containing data as a defective area when the recorded data is control data.

FIG. 1

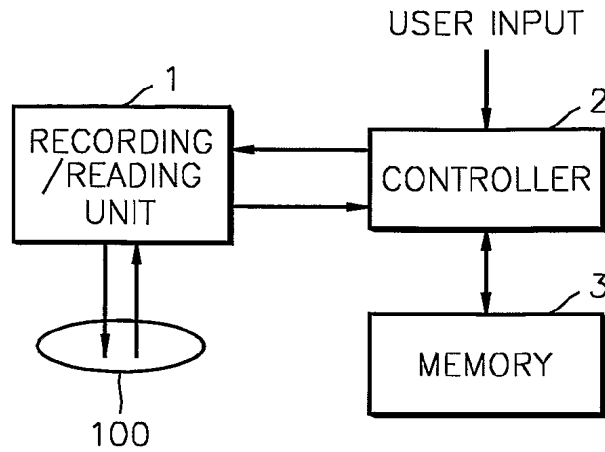

FIG. 2A

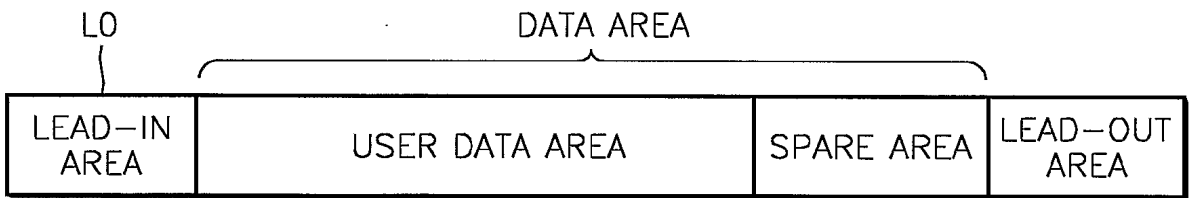
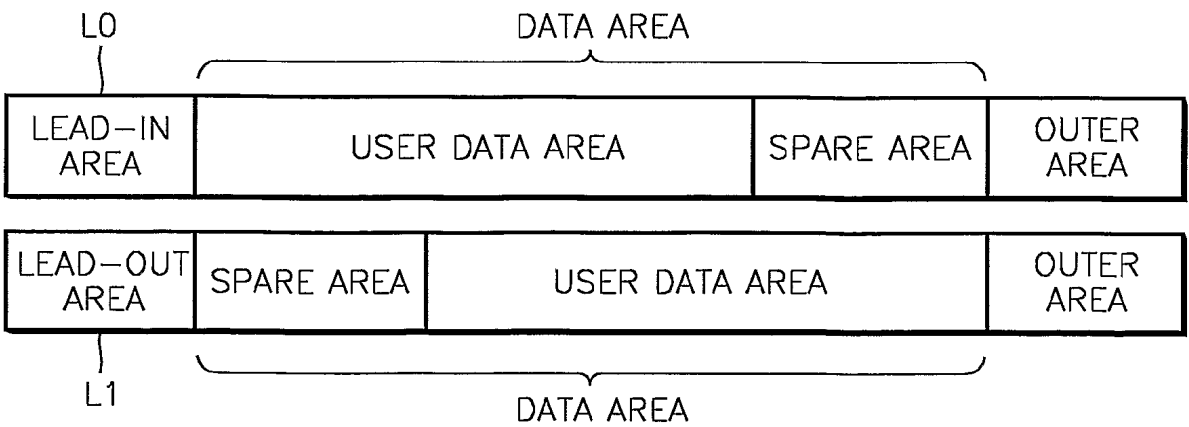

FIG. 2B



2/7

FIG. 3

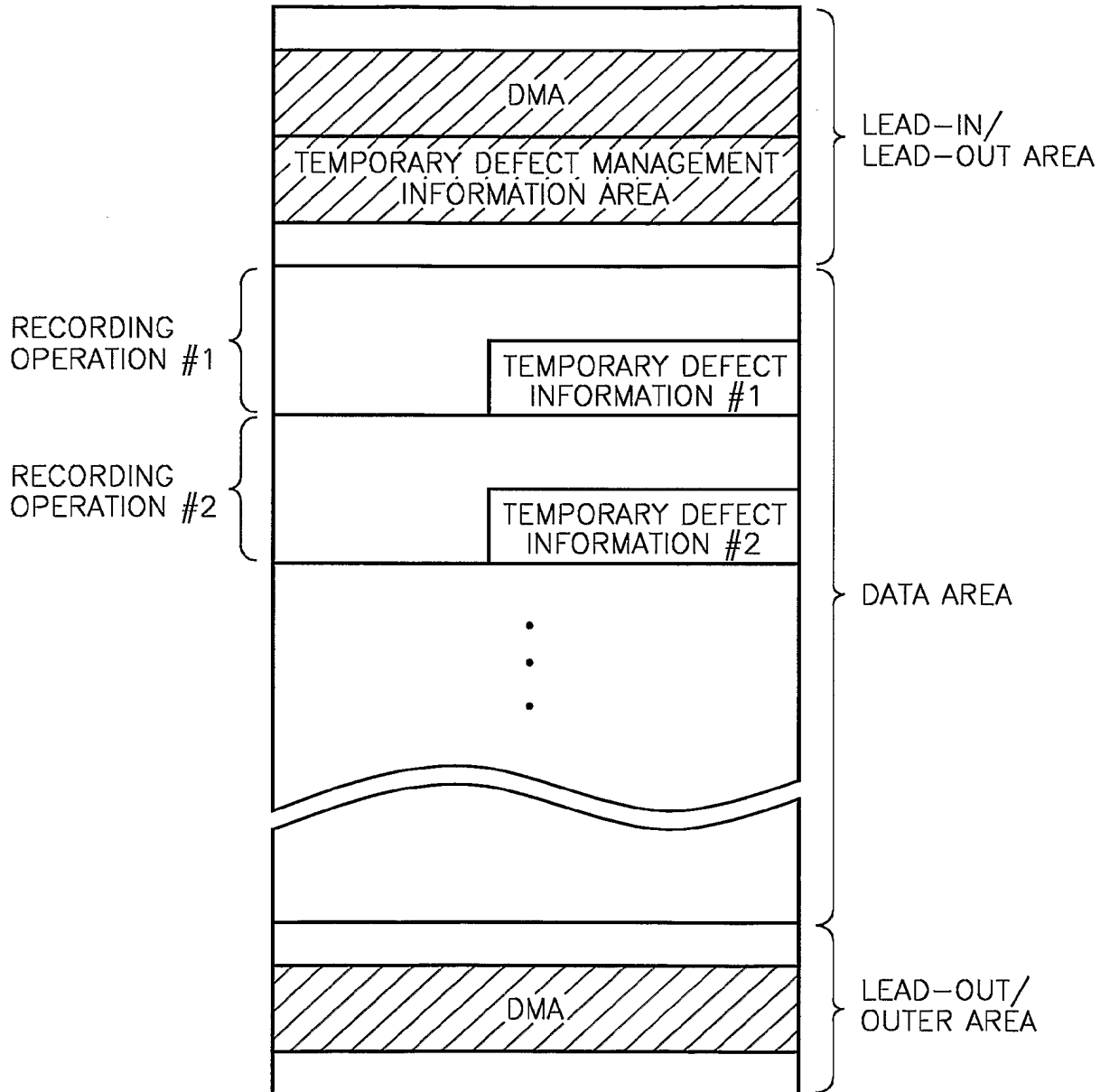
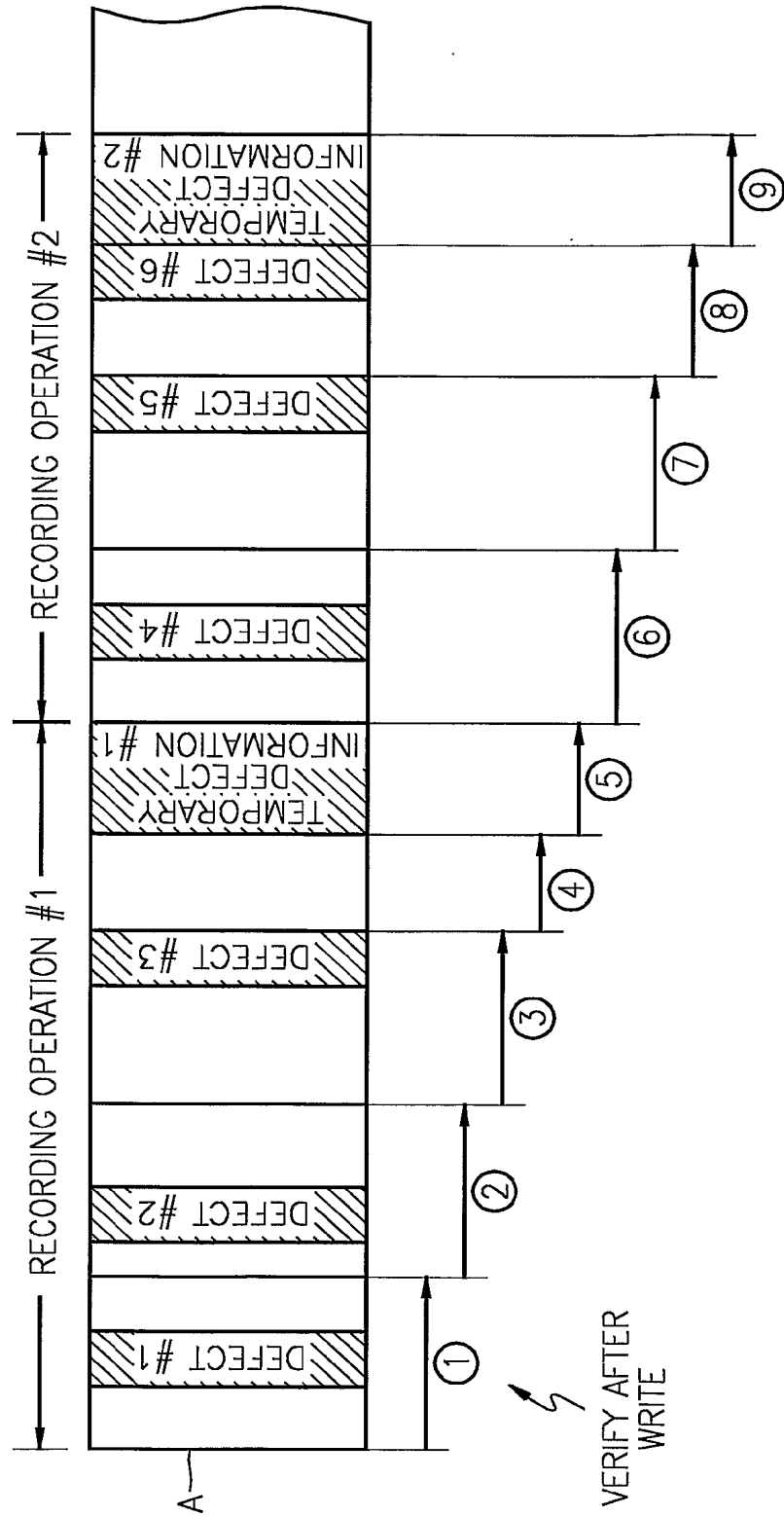

FIG. 4



4/7

FIG. 5A

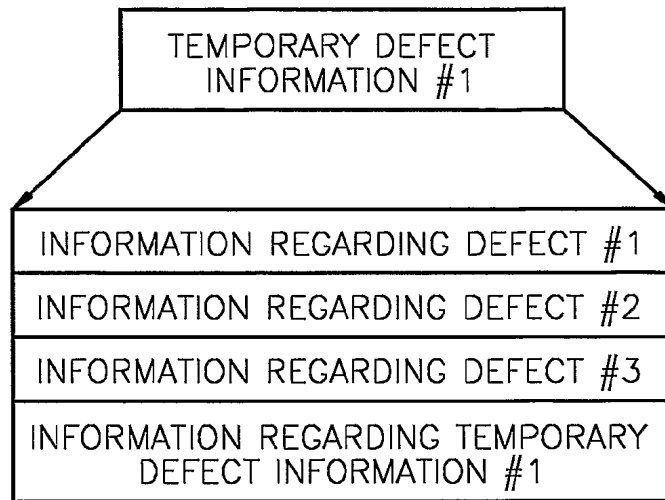
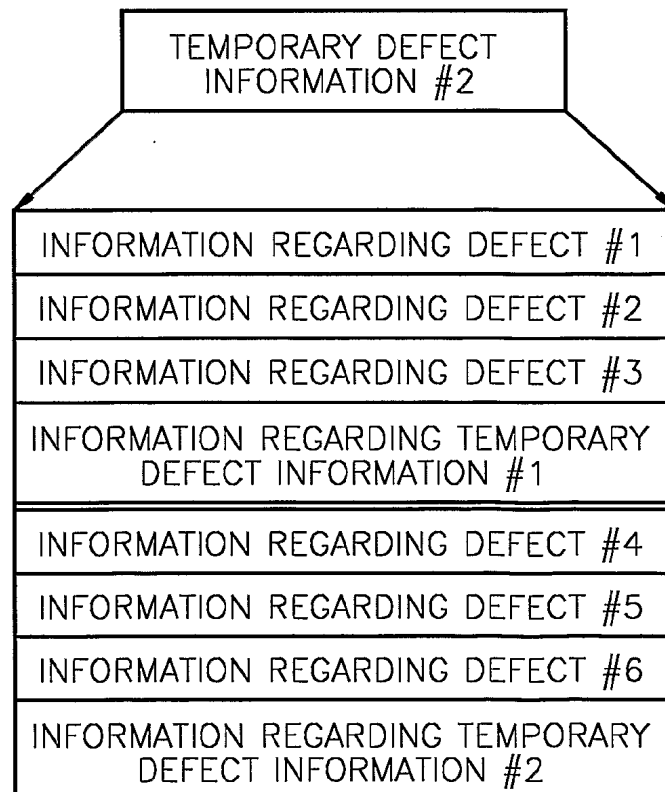

FIG. 5B



5/7

FIG. 6A

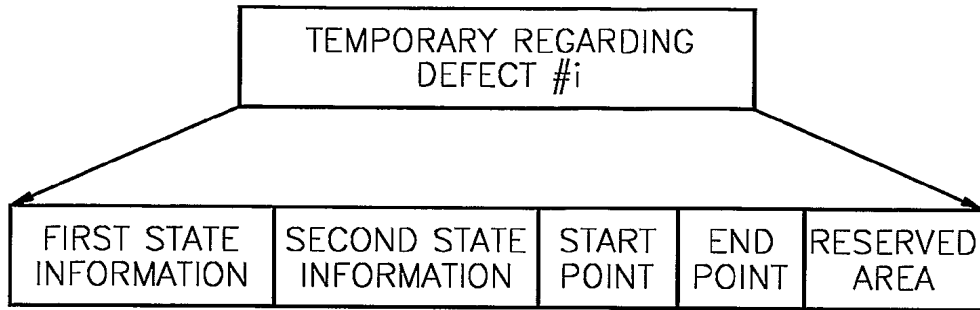
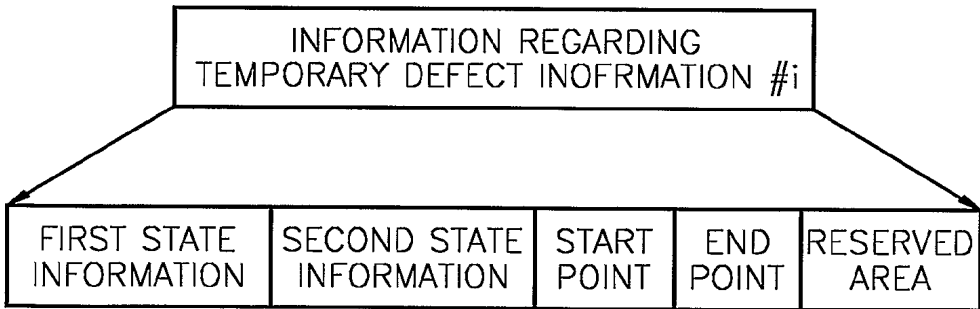
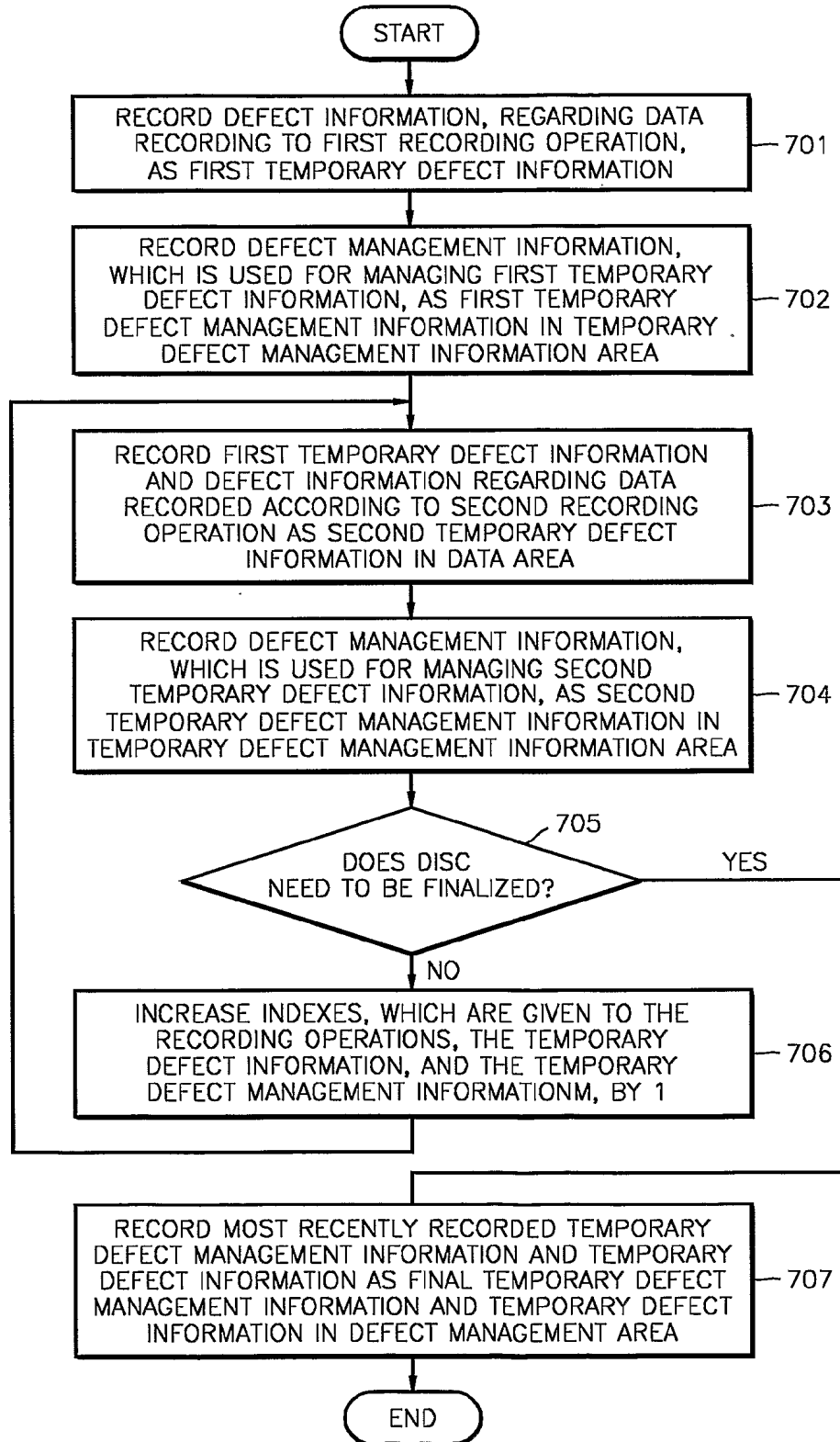

FIG. 6B



6/7

FIG. 7



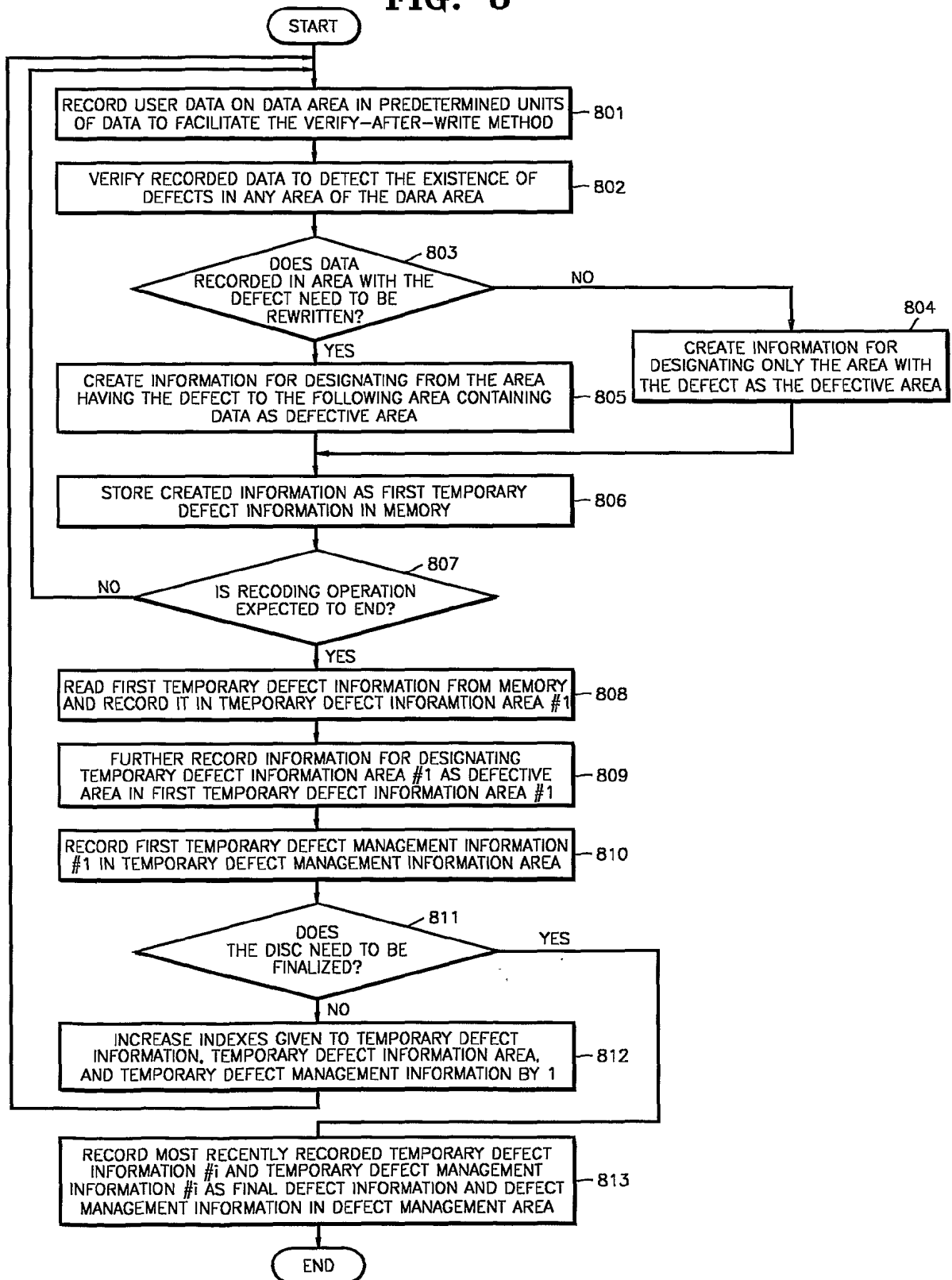

7/7
FIG. 8



INTERNATIONAL SEARCH REPORT

International application No.
PCT/KR03/01878

A. CLASSIFICATION OF SUBJECT MATTER		
IPC7 G11B 20/18		
According to International Patent Classification (IPC) or to both national classification and IPC		
B. FIELDS SEARCHED		
Minimum documentation searched (classification system followed by classification symbols) IPC 7 G11B 20/18 G11B 20/12 G11B 7/00		
Documentation searched other than minimum documentation to the extent that such documents are included in the fields searched Korea Patents and applications for inventions since 1975 Korea Utility models and applications for utility models 1975		
Electronic data base consulted during the international search (name of data base and, where practicable, search terms used) "defect", "manage", "WORM" or "write-once", "optical disc"		
C. DOCUMENTS CONSIDERED TO BE RELEVANT		
Category*	Citation of document, with indication, where appropriate, of the relevant passages	Relevant to claim No.
Y A	US 6,385,148 B2(MATSUSHITA) 7 MAY 2002 See the whole documents	1, 5, 10, 14 2-4, 6-9, 11-13, 15-18
A	WO 01/75879 A1(MATSUSHITA) 11 OCTOBER 2001 See the whole documents	1-18
A	EP 0350920 A2(MATSUSHITA) 17 JANUARY 1990 See the whole documents	1-18
A	US 4,835,757 A(TOSHIBA) 30 MAY 1989 See the whole documents	1-18
A	US 6,367,038 B1 (SAMSUNG) 2 APRIL 2002 See the whole documents	1-18
<input type="checkbox"/> Further documents are listed in the continuation of Box C. <input checked="" type="checkbox"/> See patent family annex.		
* Special categories of cited documents:	"T" later document published after the international filing date or priority date and not in conflict with the application but cited to understand the principle or theory underlying the invention	
"A" document defining the general state of the art which is not considered to be of particular relevance	"X" document of particular relevance; the claimed invention cannot be considered novel or cannot be considered to involve an inventive step when the document is taken alone	
"E" earlier application or patent but published on or after the international filing date	"Y" document of particular relevance; the claimed invention cannot be considered to involve an inventive step when the document is combined with one or more other such documents, such combination being obvious to a person skilled in the art	
"L" document which may throw doubts on priority claim(s) or which is cited to establish the publication date of citation or other special reason (as specified)	"&" document member of the same patent family	
"O" document referring to an oral disclosure, use, exhibition or other means		
"P" document published prior to the international filing date but later than the priority date claimed		
Date of the actual completion of the international search 27 DECEMBER 2003 (27.12.2003)	Date of mailing of the international search report 27 DECEMBER 2003 (27.12.2003)	
Name and mailing address of the ISA/KR  Korean Intellectual Property Office 920 Dunsan-dong, Seo-gu, Daejeon 302-701, Republic of Korea Facsimile No. 82-42-472-7140	Authorized officer HAN, Choong Hee Telephone No. 82-42-481-5700	

INTERNATIONAL SEARCH REPORT

Information on patent family members

International application No.

PCT/KR03/01878

Patent document cited in search report	Publication date	Patent family member(s)	Publication date
US 6,385,148 B2	07 MAY 2002	WO 00/54274 A1 EP 1043723 B1	14 SEP 2000 20 FEB 2002
WO 01/75879 A1	11 OCT 2001	US 2003/156471 A1 KR 2002-0087483 A	21 AUG 2003 22 NOV 2002
EP 0350920 A2	17 JAN 1990	JP 02-23417 A US 5,111,444 A	25 JAN 1990 05 MAY 1992
US 4,835,757 A	30 MAY 1989	JP 63-58672 A DE 3728857 A1	14 MAR 1988 10 MAR 1988
US 6,367,038 B1	02 APR 2002	KR 2000-034797 A JP 2003-115171 A2 EP 1260983 A3	26 JUN 2000 18 APR 2003 02 MAY 2003